

Desk Mount Articulating Monitor Arm with Cable Management and Gas Spring Height Adjust

ARMPIVOTE



*actual product may vary from photos

DE: Bedienungsanleitung - de.startech.com

FR: Guide de l'utilisateur - fr.startech.com

ES: Guía del usuario - es.startech.com

IT: Guida per l'uso - it.startech.com

NL: Gebruiksaanwijzing - nl.startech.com

PT: Guia do usuário - pt.startech.com

For the most up-to-date information, please visit: www.startech.com

FCC Compliance Statement

This equipment has been tested and found to comply with the limits for a Class B digital device, pursuant to part 15 of the FCC Rules. These limits are designed to provide reasonable protection against harmful interference in a residential installation. This equipment generates, uses and can radiate radio frequency energy and, if not installed and used in accordance with the instructions, may cause harmful interference to radio communications. However, there is no guarantee that interference will not occur in a particular installation. If this equipment does cause harmful interference to radio or television reception, which can be determined by turning the equipment off and on, the user is encouraged to try to correct the interference by one or more of the following measures:

- Reorient or relocate the receiving antenna.
- Increase the separation between the equipment and receiver.
- Connect the equipment into an outlet on a circuit different from that to which the receiver is connected.
- Consult the dealer or an experienced radio/TV technician for help.

Use of Trademarks, Registered Trademarks, and other Protected Names and Symbols







This manual may make reference to trademarks, registered trademarks, and other protected names and/or symbols of third-party companies not related in any way to StarTech.com. Where they occur these references are for illustrative purposes only and do not represent an endorsement of a product or service by StarTech.com, or an endorsement of the product(s) to which this manual applies by the third-party company in question. Regardless of any direct acknowledgement elsewhere in the body of this document, StarTech.com hereby acknowledges that all trademarks, registered trademarks, service marks, and other protected names and/or symbols contained in this manual and related documents are the property of their respective holders.

Table of Contents

Introduction	ii
Packaging Contents	ii
Product Diagram	1
Installation	2
Desk / Grommet Mounting	2
Attaching the Display	4
Attaching the Gas Spring Arm Assembly	5
Cable Management	6
Adjusting the Gas Spring Arm Resistance	7
Specifications	9
Technical Support	10
Warranty Information	10

Introduction

Packaging Contents

<p>1</p>  <p>Gas Spring Arm Qty. 1</p>	<p>2</p>  <p>Extension Arm Qty. 1</p>	<p>3</p>  <p>Pole Qty. 1</p>
<p>4</p>  <p>Clamp Qty. 1</p>	<p>5</p>  <p>Allen Wrench 4mm Qty. 1</p>	<p>6</p>  <p>Allen Wrench 6mm Qty. 1</p>
<p>7</p>  <p>Cable Clip Qty. 1</p>	<p>8</p>  <p>Cable Cover Qty. 5</p>	<p>9</p>  <p>Cover and Bolt Qty. 1</p>
<p>10</p>  <p>Spacer Qty. 4</p>	<p>11</p>  <p>Philips Screw M4x12mm Qty. 4</p>	<p>12</p>  <p>Philips Screw M4x25mm Qty. 4</p>
<p>13</p>  <p>Plastic Gasket Cushion Qty. 2</p>		

Product Diagram

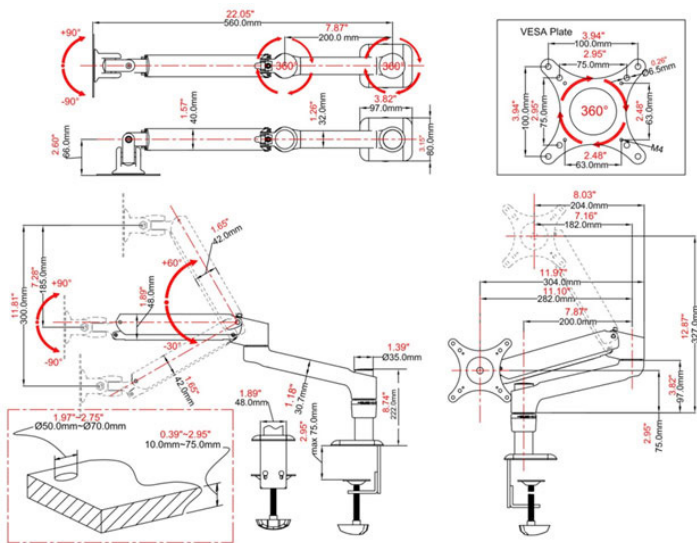

Installation

WARNING! It is the installer's responsibility to ensure that the combined weight of all components does not exceed the maximum **8 lb (3.6 kg)** weight capacity of the mounting arm.

Desk / Grommet Mounting

The Monitor Arm can be clamped to a desk / table, or mounted through a grommet hole. Instructions for both will be provided in the steps below.

1. **Desk / Grommet Clamp:** Remove the Left Cover and insert the L Plate portion of the Clamp (4) into the base of the Pole (3) before replacing the Left Cover, then apply the Plastic Gasket Cushions (13) as shown.

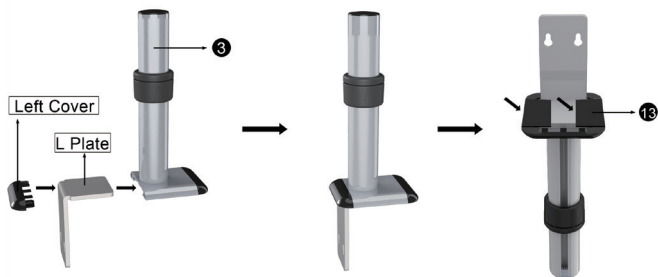

2. **Desk Clamp:** Attach the bottom portion of the Clamp (4) to the L Plate, then place the Clamp (4) opening around the edge of your desktop in your desired location and tighten by hand to secure. Ensure that the Clamp is making full contact with the desk surface.

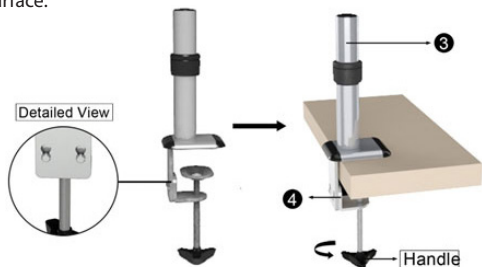

- Grommet Clamp:** Place the L Plate through the grommet hole of your desk surface, then attach the bottom portion of the Clamp (4) to the L Plate and tighten by hand to secure. Ensure that the Clamp is making full contact with the desk surface.

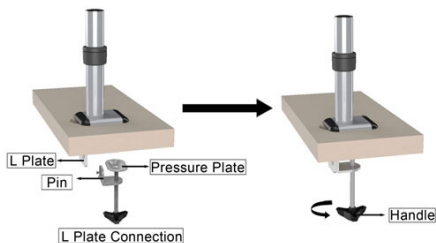

3. Loosen the collar on the support post and adjust to the desired height.



Attaching the Display

1. Carefully place your display face down on a protective surface to access the mounting points.

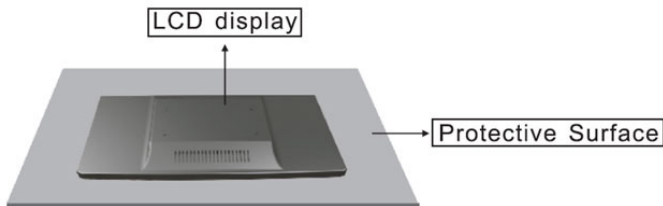

2. Depending on the depth of the mounting holes on your display, attach the display to the Gas Spring Arm (1) using either the M4x12mm (11) screws, or the M4x25mm (12) screws with spacers (10). Tighten using a Phillips screwdriver.

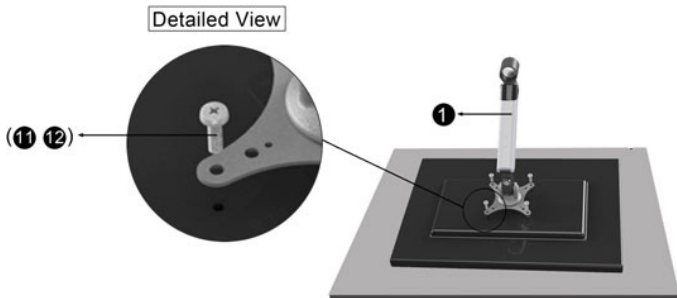

WARNING! Do not over-tighten the screws and stop immediately if you encounter resistance to avoid damage to your display. Ensure that all spacers and screws being used are the same length and thread type.

Attaching the Gas Spring Arm Assembly

1. Slide the Extension Arm (2) down onto the Pole (3).

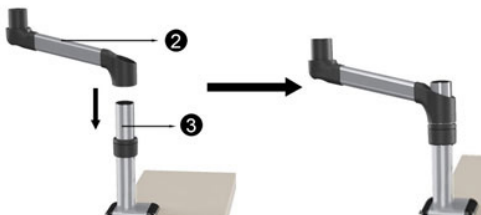

2. Slide the Gas Spring Arm (1) onto the Extension Arm (2).

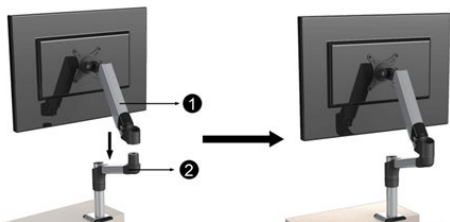

3. Place the Cover and Bolt (9) onto the Gas Spring Arm (1) and press the bolt down to secure the two arms together.

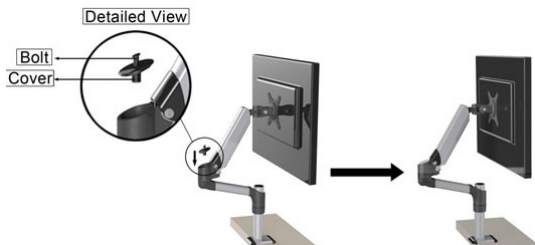

Cable Management

Note: When attaching cables and routing through the cable management channels, ensure that you leave enough slack to avoid stretching / pulling out the cables when moving the arm.

1. Connect your cables to your display and position the mounting arm in its fully extended position to ensure that the cables you are using are long enough to allow for proper movement.
2. Feed the cables into the cable management channels on the underside of the arms as shown.

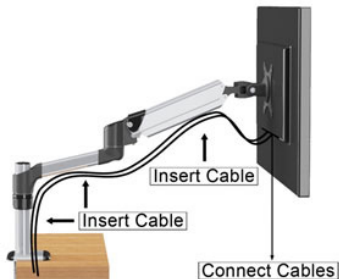

3. Press the Cable Covers (**8**) into the slots as shown.

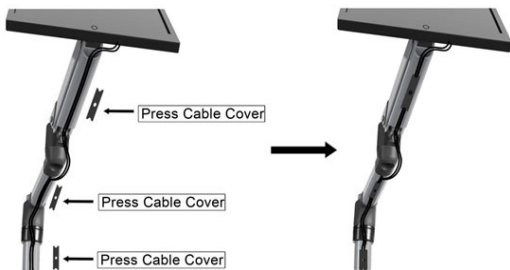

4. Use the Cable Clip (7) to secure the display cables to the pole.

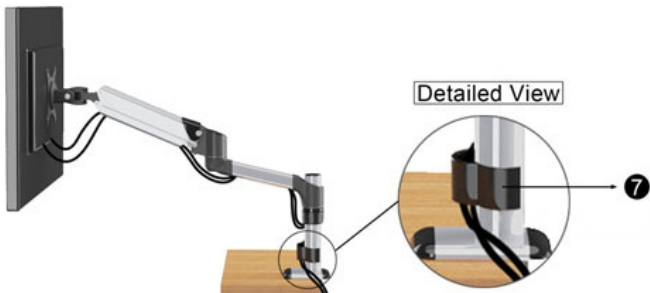

Adjusting the Gas Spring Arm Resistance

WARNING! Forced movement of the LCD Arms or Mount Brackets without loosening the screws may damage the product or the mounted displays.

Always support your display from underneath when making any adjustments to the LCD Arms or Mount Brackets to avoid damage to the display.



Note: For all adjustments outlined below, turning the screw clockwise will increase the resistance, while turning the screw counter-clockwise will decrease resistance.

To increase / decrease the Gas Spring Arm resistance, adjust the set screw located at the elbow of the articulating arm, using the 4mm Allen Wrench (5).

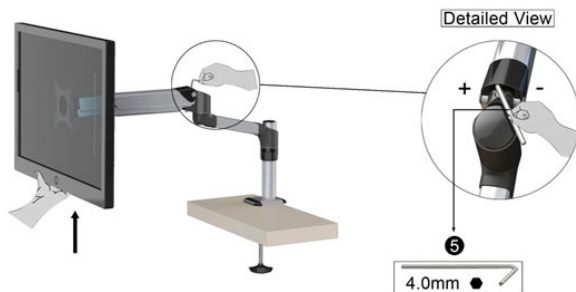

To increase / decrease the tilt resistance, adjust the set screw located on the side of the Mount Bracket joint, using the 6mm Allen Wrench (6).

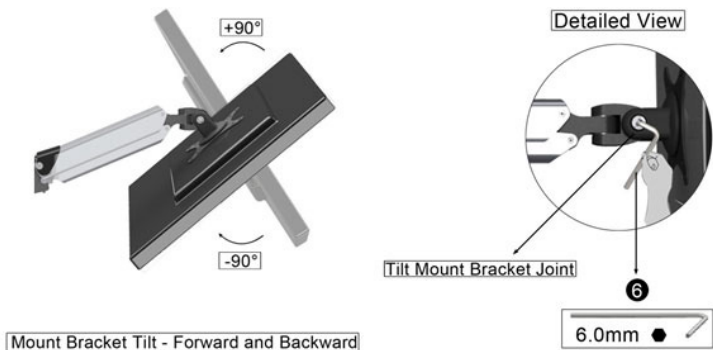

Specifications

Weight Capacity	8 lb (3.6 kg)
Max Display Size	24"
VESA Compatibility	75 x 75 mm and 100 x 100 mm
Maximum Extension	22.05 in (560mm)
Maximum Mounting Surface Thickness	2.95 in (75 mm)

Technical Support

StarTech.com's lifetime technical support is an integral part of our commitment to provide industry-leading solutions. If you ever need help with your product, visit www.startech.com/support and access our comprehensive selection of online tools, documentation, and downloads.

For the latest drivers/software, please visit www.startech.com/downloads

Warranty Information

This product is backed by a two year warranty.

In addition, StarTech.com warrants its products against defects in materials and workmanship for the periods noted, following the initial date of purchase. During this period, the products may be returned for repair, or replacement with equivalent products at our discretion. The warranty covers parts and labor costs only. StarTech.com does not warrant its products from defects or damages arising from misuse, abuse, alteration, or normal wear and tear.

Limitation of Liability

In no event shall the liability of StarTech.com Ltd. and StarTech.com USA LLP (or their officers, directors, employees or agents) for any damages (whether direct or indirect, special, punitive, incidental, consequential, or otherwise), loss of profits, loss of business, or any pecuniary loss, arising out of or related to the use of the product exceed the actual price paid for the product. Some states do not allow the exclusion or limitation of incidental or consequential damages. If such laws apply, the limitations or exclusions contained in this statement may not apply to you.

Hard-to-find made easy. At StarTech.com, that isn't a slogan. It's a promise.

StarTech.com is your one-stop source for every connectivity part you need. From the latest technology to legacy products — and all the parts that bridge the old and new — we can help you find the parts that connect your solutions.

We make it easy to locate the parts, and we quickly deliver them wherever they need to go. Just talk to one of our tech advisors or visit our website. You'll be connected to the products you need in no time.

Visit www.startech.com for complete information on all StarTech.com products and to access exclusive resources and time-saving tools.

StarTech.com is an ISO 9001 Registered manufacturer of connectivity and technology parts. StarTech.com was founded in 1985 and has operations in the United States, Canada, the United Kingdom and Taiwan servicing a worldwide market.