

Universal Tripod Floor Stand for Tablets

STNDTBLT1A5T



*actual product may vary from photos

DE: Bedienungsanleitung - de.startech.com

FR: Guide de l'utilisateur - fr.startech.com

ES: Guía del usuario - es.startech.com

IT: Guida per l'uso - it.startech.com

NL: Gebruiksaanwijzing - nl.startech.com

PT: Guia do usuário - pt.startech.com

For the latest information, technical specifications, and support for this product, please visit www.startech.com/STNDTBLT1A5T.

Use of Trademarks, Registered Trademarks, and other Protected Names and Symbols

This manual may make reference to trademarks, registered trademarks, and other protected names and/or symbols of third-party companies not related in any way to StarTech.com. Where they occur these references are for illustrative purposes only and do not represent an endorsement of a product or service by StarTech.com, or an endorsement of the product(s) to which this manual applies by the third-party company in question. Regardless of any direct acknowledgement elsewhere in the body of this document, StarTech.com hereby acknowledges that all trademarks, registered trademarks, service marks, and other protected names and/or symbols contained in this manual and related documents are the property of their respective holders.

Table of Contents

| | |
|--|----------|
| Product diagram | 1 |
| Front view of tablet holder | 1 |
| Rear view of tablet holder | 1 |
| Introduction | 2 |
| Packaging contents | 2 |
| Product overview | 3 |
| Assemble the tripod | 4 |
| Attach a tablet to the tripod | 6 |
| Adjust the tablet holder | 7 |
| Remove the tablet | 7 |
| Technical support | 8 |
| Warranty information | 8 |

Product diagram

Front view of tablet holder



Rear view of tablet holder

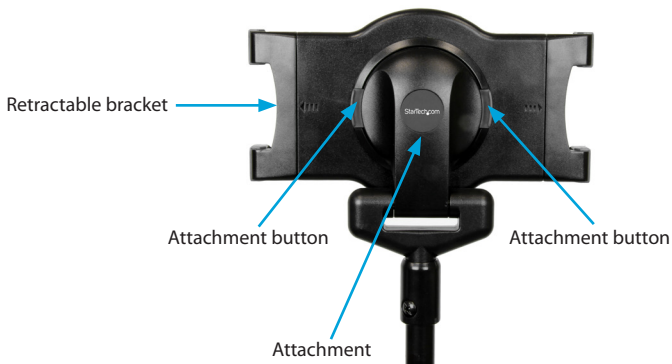

Introduction

The STNDTBLT1A5T features a universal tablet mount that fits tablets ranging in size from 6.5" to 7.8" (166 to 200 mm) in width, with a maximum tablet thickness of 0.45" / 11.5 mm and a tripod floor stand to provide a stable base for the tablet holder to sit on. The STNDTBLT1A5T also comes with a carrying case, making it convenient to transport the tablet stand or store it when it's not in use.

Packaging contents

1.

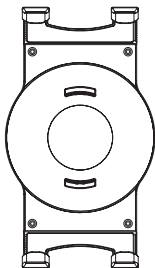

Tablet holder

Quantity: One

2.

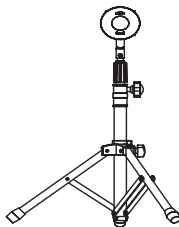

Tripod stand with extension pole

Quantity: One

3.



Carrying bag

Quantity: One

4.



Instruction manual

Quantity: One

Product overview

Dimensions of tripod when it's not extended and the tablet holder is attached

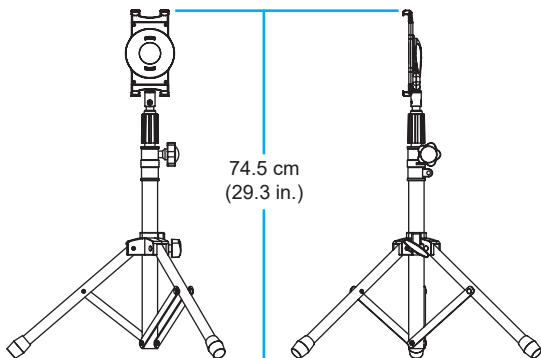

Dimensions of tripod when it's extended and the tablet holder is attached

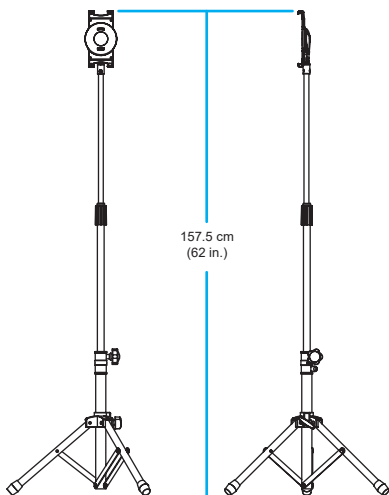

Assemble the tripod

1. Hold the tripod pole and turn the knob on the tripod to the left to loosen the legs on the tripod stand.

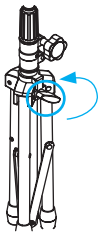

2. Pull out all three of the legs and turn the knob on the tripod to the right to lock the legs in place.

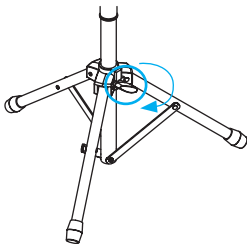

3. Turn the hand screw on the pole of the tripod to the left to loosen it.

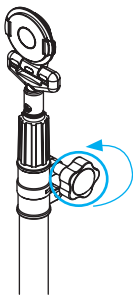

4. Move the tripod pole up or down to your desired height and turn the hand screw on the tripod to the right to tighten it.

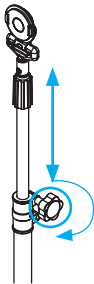

5. Turn the joiner that connects the two halves of the tripod pole to the left to loosen it.

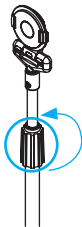

6. Move the tripod pole up or down to your desired height and turn the joiner to the right to tighten it.

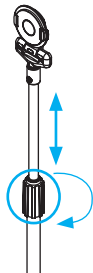

Attach a tablet to the tripod

The universal tablet mount fits tablets ranging in size from, 6.5" and 7.8" (166 mm to 200 mm) in width, with a maximum tablet thickness of 0.45" / 11.5 mm.

1. With the tablet screen facing upwards, slide one of the long sides of the tablet into one of the retractable brackets on the tablet holder.

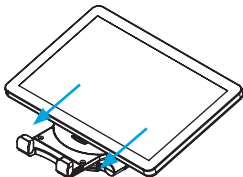

2. Pull out the other retractable bracket to open it up and place the bracket claw over the other side of the tablet. Gently release the bracket.

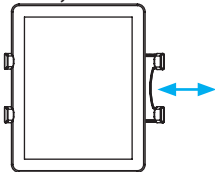

Caution! Make sure that the tablet is securely fixed into the tablet holder before you proceed to the next step and attach the tablet holder to the tripod.

3. Press and hold the buttons on either side of the attachment at the end of the tripod pole.
4. Align the tablet holder with the attachment at the end of the tripod pole and release the buttons.

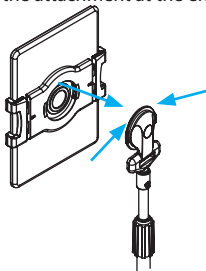

Adjust the tablet holder

The tablet holder moves in 90 degree increments in either direction, so the tablet can be in either landscape or portrait position. To move the tablet holder, grasp the side of the tablet and move it in the direction that you want it to go in. When you have moved the tablet holder 90 degrees, you will hear a click to indicate that the tablet holder is in place.

You can also adjust the angle of the tablet holder by pulling it forward or backward. Additionally, the tablet holder also swivels up to 180 degrees. To move the tablet holder, grasp the side of the tablet and swivel it to the right or left to the position that you want it to be in.

Remove the tablet

1. Hold the tablet holder while you press and hold the buttons on either side of the attachment at the end of the tripod pole.

Warning! Make sure that you have a secure hold on the tablet holder before you press the buttons.

2. Pull the tablet holder off of the tripod pole and release the buttons that you were pressing.
3. Pull one of the retractable brackets away from the side of the tablet.
4. Slide the tablet out from under the retractable bracket and pull it free from the tablet holder.

Technical support

StarTech.com's lifetime technical support is an integral part of our commitment to provide industry-leading solutions. If you ever need help with your product, visit www.startech.com/support and access our comprehensive selection of online tools, documentation, and downloads.

For the latest drivers/software, please visit www.startech.com/downloads

Warranty information

This product is backed by a two-year warranty.

StarTech.com warrants its products against defects in materials and workmanship for the periods noted, following the initial date of purchase. During this period, the products may be returned for repair, or replacement with equivalent products at our discretion. The warranty covers parts and labor costs only. StarTech.com does not warrant its products from defects or damages arising from misuse, abuse, alteration, or normal wear and tear.

Limitation of Liability

In no event shall the liability of StarTech.com Ltd. and StarTech.com USA LLP (or their officers, directors, employees or agents) for any damages (whether direct or indirect, special, punitive, incidental, consequential, or otherwise), loss of profits, loss of business, or any pecuniary loss, arising out of or related to the use of the product exceed the actual price paid for the product. Some states do not allow the exclusion or limitation of incidental or consequential damages. If such laws apply, the limitations or exclusions contained in this statement may not apply to you.

Hard-to-find made easy. At StarTech.com, that isn't a slogan. It's a promise.

StarTech.com is your one-stop source for every connectivity part you need. From the latest technology to legacy products — and all the parts that bridge the old and new — we can help you find the parts that connect your solutions.

We make it easy to locate the parts, and we quickly deliver them wherever they need to go. Just talk to one of our tech advisors or visit our website. You'll be connected to the products you need in no time.

Visit www.startech.com for complete information on all StarTech.com products and to access exclusive resources and time-saving tools.

StarTech.com is an ISO 9001 Registered manufacturer of connectivity and technology parts. StarTech.com was founded in 1985 and has operations in the United States, Canada, the United Kingdom and Taiwan servicing a worldwide market.